

Contents

Lowercase letter practice.....	p5 - p30
Lowercase letter review.....	p31 - p32
Uppercase letter practice.....	p33 - p58
Uppercase letter review.....	p59 - p60
Vowel sounds	p61 - p62
Consonant sound b/p and t/d.....	p63 - p64
Consonant sound c/g and k/q.....	p65 - p66
Consonant sound j/y and w/h.....	p67 - p68
Consonant sound s/z and f/v.....	p69 - p70
Consonant sound l/r and m/n.....	p71 - p72
Lined pages.....	p73 - p80

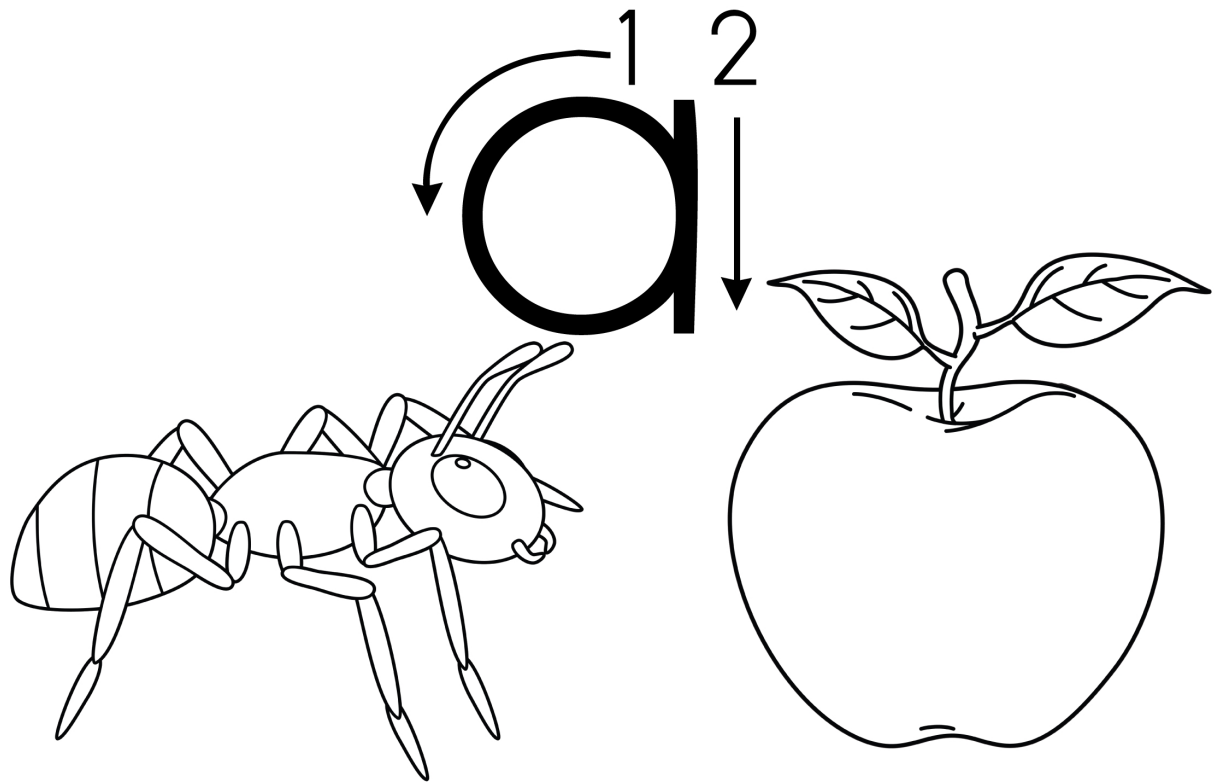

Say the letter. Trace the letter. Write the letter.

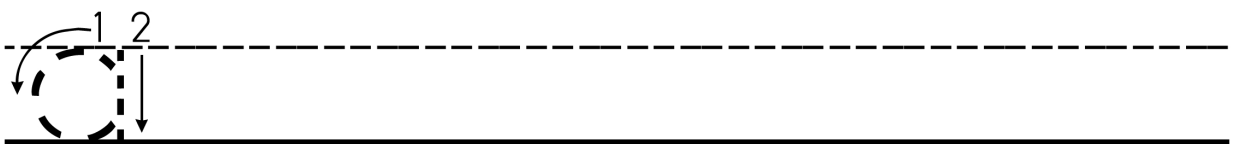
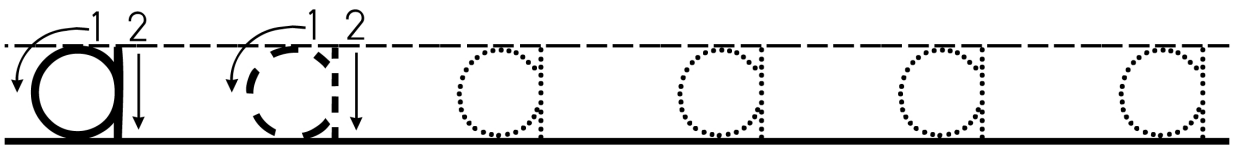

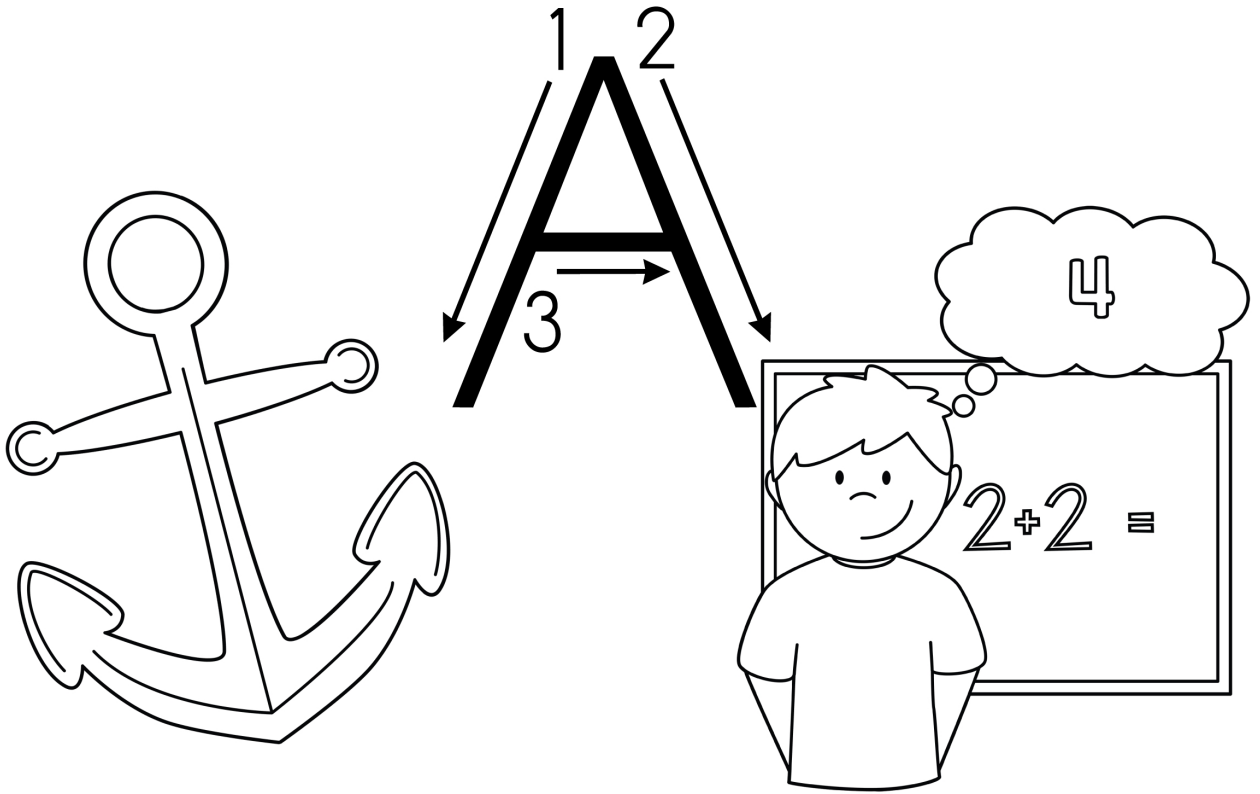

Say the letter. Trace the letter. Write the letter.

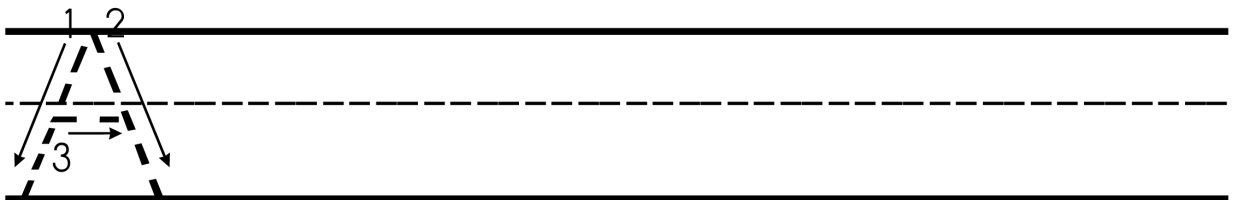
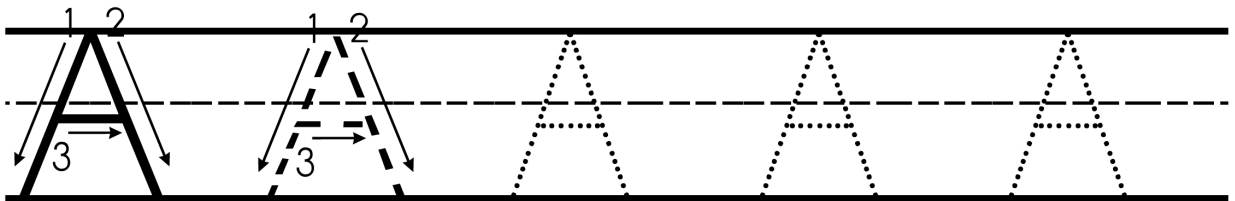
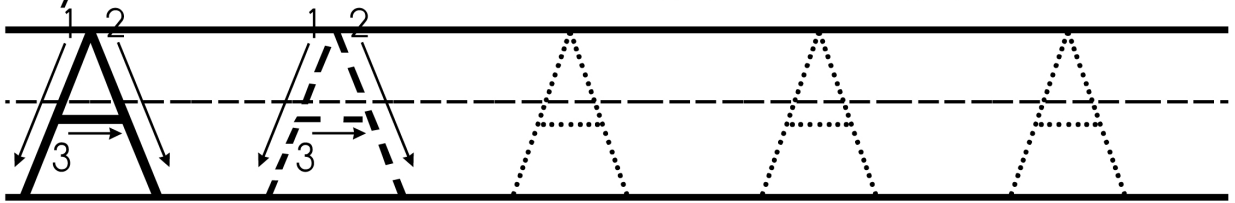

Circle the picture that begins with the sound in the box.

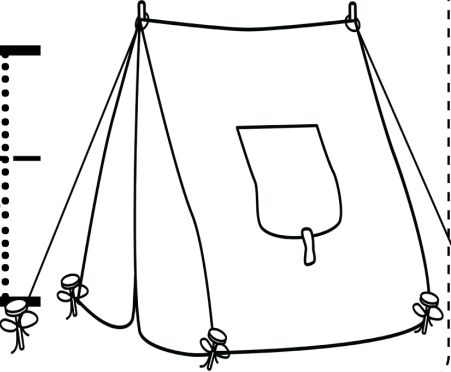
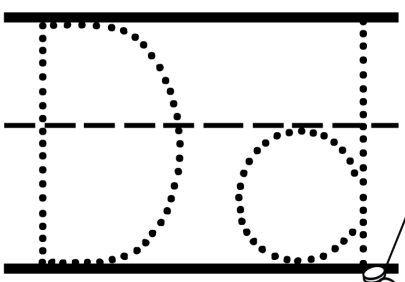
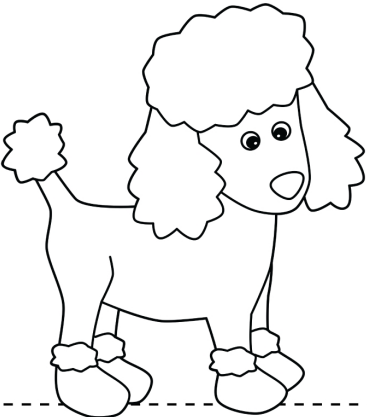
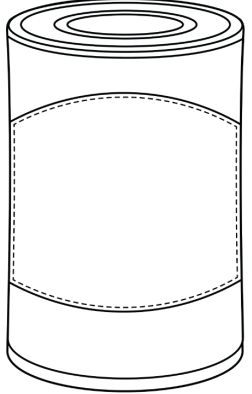
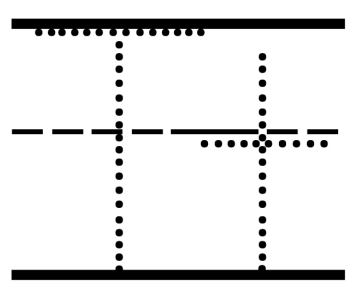
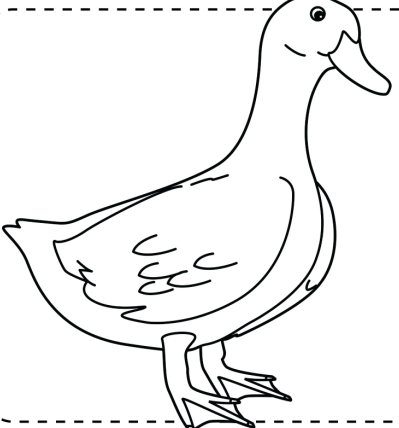
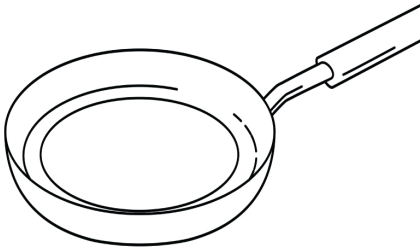
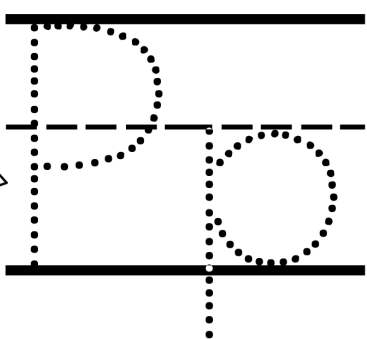
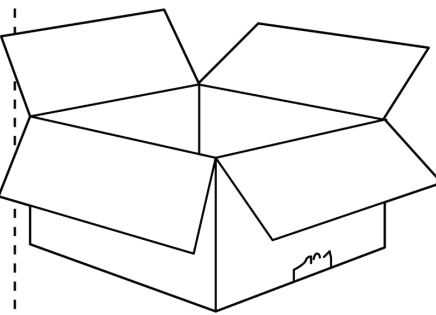
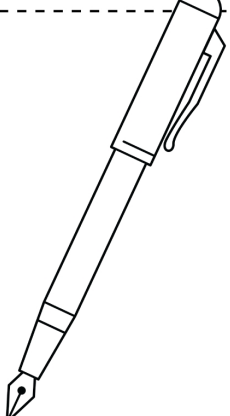
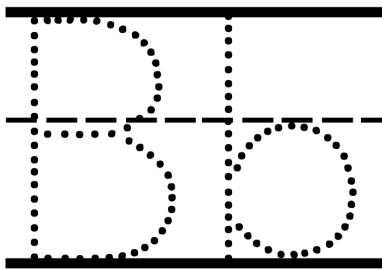
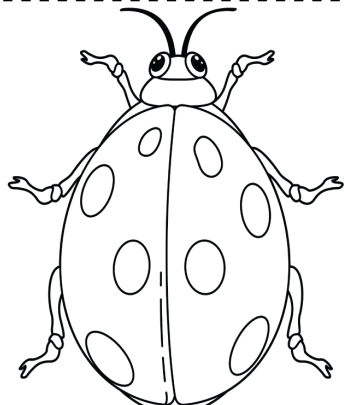

Complete the word with the correct sound.

Bb

Pp

Tt

Dd

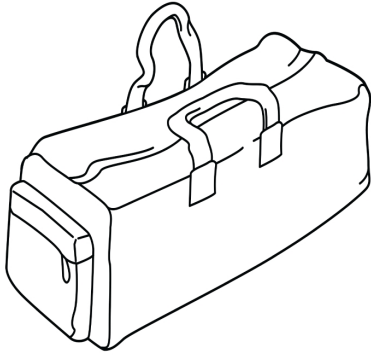

__ag

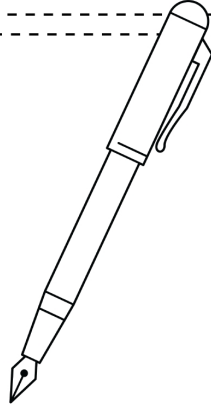

__en

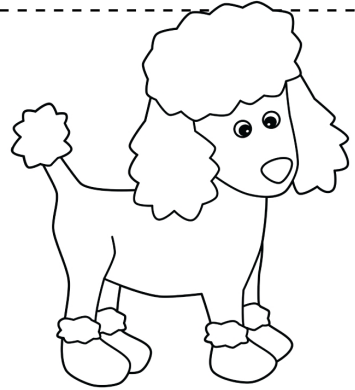

__og

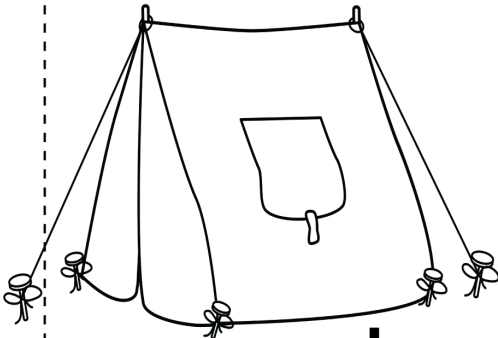

__ent

io

__en

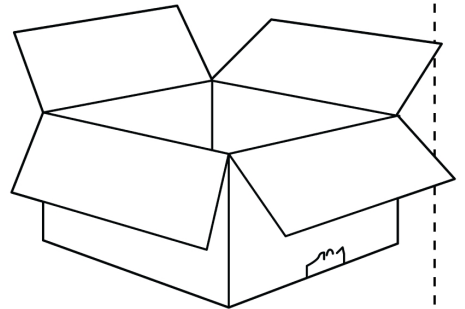

__ox

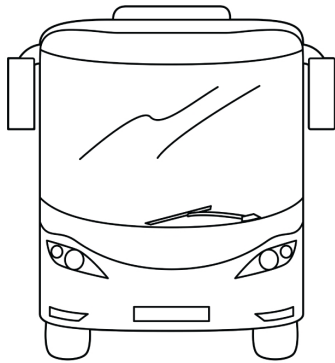

__us

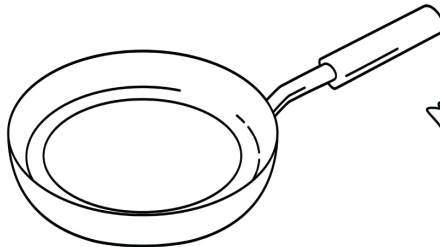

__an

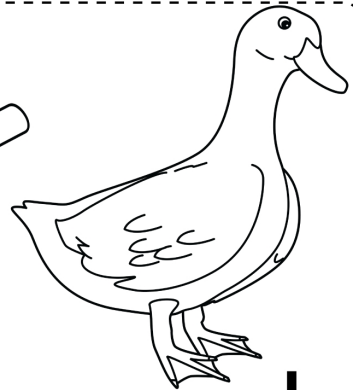

__uck